

非常用照明器具特性

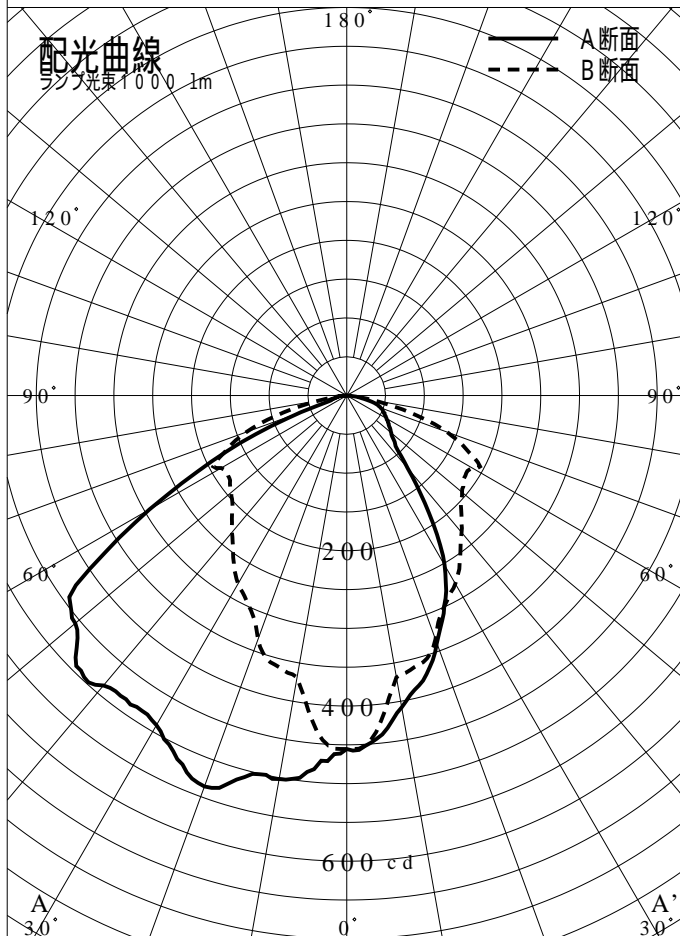

品番	NNCF40735		
名称			
光源	LED5000/97/535		
管理番号	K0169473(1)DR1		
光束	5351m x 1.00		
保守率	0.92		
適用品番	設計照度Eを得るための読取照度		
	E=2.0	E=1.0	E=0.5
NNCF40735	4.1	2.0	1.0
備考	非常点灯時の照度(60分後)		

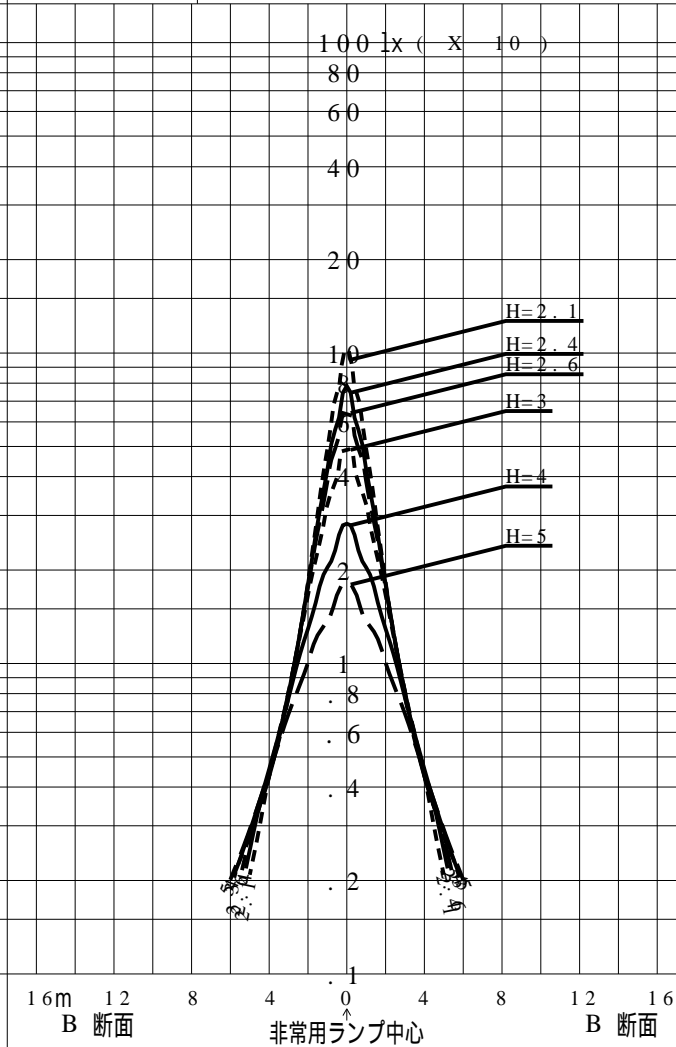
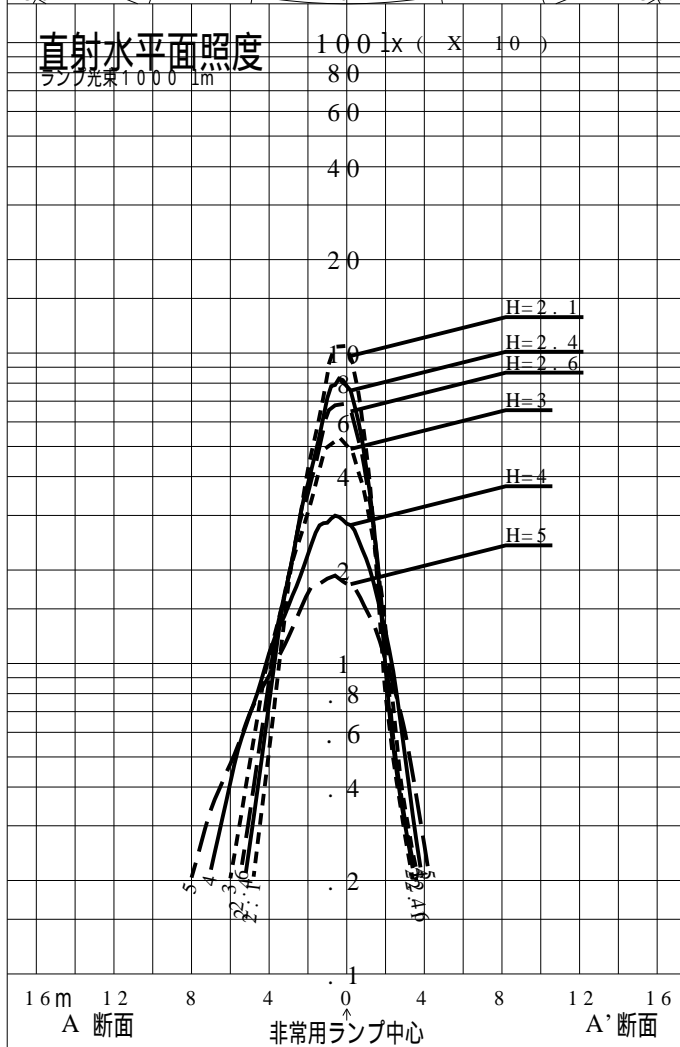

品番	NNCF40735				
名称					
光源	LED5000/97/535				
管理番号	K0169473(1)DR 1				
光束	535.0 1m * 1.00			備考	非常点灯時の照度 (60分後)
保守率	0.92				

非常灯配置表

器具取付高さ (m)		2.1	2.2	2.3	2.4	2.5	2.6	2.7	2.8	2.9	3.0	3.1	3.2	3.3	3.4	3.5	3.6
単体配置	A1	4.2	4.3	4.5	4.6	4.7	4.8	4.9	5.0	5.1	5.2	5.3	5.4	5.5	5.6	5.6	5.7
	A'1	2.6	2.6	2.7	2.7	2.7	2.7	2.8	2.8	2.8	2.8	2.9	2.9	3.0	3.0	3.0	3.1
	B1	4.1	4.2	4.2	4.2	4.2	4.2	4.2	4.2	4.2	4.2	4.2	4.2	4.2	4.2	4.2	4.3
直線配置	A2	7.8	8.0	8.2	8.3	8.5	8.6	8.7	9.0	9.1	9.2	9.3	9.6	9.6	9.7	9.9	10.2
	B2	8.9	9.1	9.3	9.5	9.7	9.9	10.1	10.3	10.4	10.6	10.7	10.9	11.0	11.1	11.3	11.4
四角配置	A4	5.5	5.6	5.8	6.0	6.2	6.4	6.6	6.8	7.0	7.2	7.4	7.6	7.9	8.1	8.4	8.5
	B4	8.6	8.8	9.0	9.1	9.2	9.4	9.4	9.5	9.7	9.7	9.8	9.9	9.9	9.8	9.8	9.9
壁からの距離 (最大)	A0	1.1	1.1	1.1	1.3	1.3	1.3	1.4	1.4	1.4	1.5	1.5	1.6	1.7	1.8	2.0	2.0
	B0	3.1	3.2	3.2	3.2	3.3	3.3	3.3	3.3	3.3	3.3	3.3	3.3	3.3	3.2	3.0	3.1

器具取付高さ (m)		3.7	3.8	3.9	4.0	4.1	4.2	4.3	4.4	4.5	5.0	5.5	6.0	6.5	7.0	7.5	8.0
単体配置	A1	5.8	5.9	6.0	6.0	6.1	6.2	6.3	6.3	6.4	6.5	6.5	6.5	6.5	6.4	6.1	5.7
	A'1	3.1	3.1	3.2	3.2	3.2	3.3	3.3	3.3	3.4	3.5	3.6	3.7	3.7	3.6	3.4	3.2
	B1	4.3	4.3	4.3	4.3	4.3	4.3	4.3	4.3	4.3	4.2	4.2	4.1	3.9	3.7	3.4	3.1
直線配置	A2	10.2	10.3	10.4	10.5	10.8	10.8	10.9	11.2	11.2	12.0	12.2	12.5	12.8	13.0	13.2	13.2
	B2	11.4	11.5	11.5	11.5	11.5	11.5	11.5	11.5	11.6	11.6	11.6	11.6	11.5	11.5	11.4	11.2
四角配置	A4	8.8	9.0	9.2	9.3	9.5	9.5	9.5	9.5	9.6	10.2	11.0	11.6	11.8	12.4	12.4	11.8
	B4	9.8	9.9	9.9	10.0	10.0	10.2	10.4	10.6	10.7	11.0	11.0	11.1	11.3	11.1	11.3	11.2
壁からの距離 (最大)	A0	2.1	2.1	2.2	2.2	2.2	2.1	2.1	2.0	1.9	1.8	1.7	1.7	1.3	1.6	1.1	1.0
	B0	2.9	3.0	2.9	2.9	2.9	2.9	3.0	3.0	3.0	3.0	2.8	2.2	2.3	1.7	1.7	2.0

器具取付高さ (m)		8.5	9.0	9.5	10.0	10.5											
単体配置	A1	5.4	5.0	4.7	4.3	----											
	A'1	2.9	2.6	2.1	1.5	----											
	B1	2.9	2.3	1.5	1.1	----											
直線配置	A2	13.1	12.9	12.8	12.6	9.5											
	B2	11.0	10.8	10.4	9.9	9.2											
四角配置	A4	12.2	12.5	12.8	12.6	9.5											
	B4	11.0	10.8	10.4	9.9	9.2											
壁からの距離 (最大)	A0	1.0	1.0	1.0	1.0	1.0											
	B0	1.6	1.5	1.2	1.2	1.0											

階段配置表

器具取付高さ (m)			1.0	1.5	2.0	2.5	3.0	4.0	5.0	6.0	7.0	8.0
Y=1.0 (m)	2.0Lx	X+	2.3	3.1	3.8	4.3	4.8	5.7	6.0	6.1	6.0	5.4
		X-	1.8	2.1	2.3	2.5	2.7	3.1	3.3	3.3	3.1	2.6
Y=1.5 (m)	1.0Lx	X+	2.6	3.6	4.4	5.1	5.7	6.8	7.8	8.5	8.9	9.0
		X-	2.1	2.9	3.6	4.2	4.7	5.3	5.5	5.5	5.1	4.6
Y=2.0 (m)	2.0Lx	X+	1.8	2.7	3.3	4.0	4.5	5.2	5.3	5.2	4.6	3.9
		X-	0.9	1.5	1.9	2.2	2.5	2.9	3.1	3.0	2.8	2.2
	1.0Lx	X+	2.2	3.2	4.0	4.7	5.4	6.5	7.3	7.7	7.8	8.0