

# 非常用照明器具特性

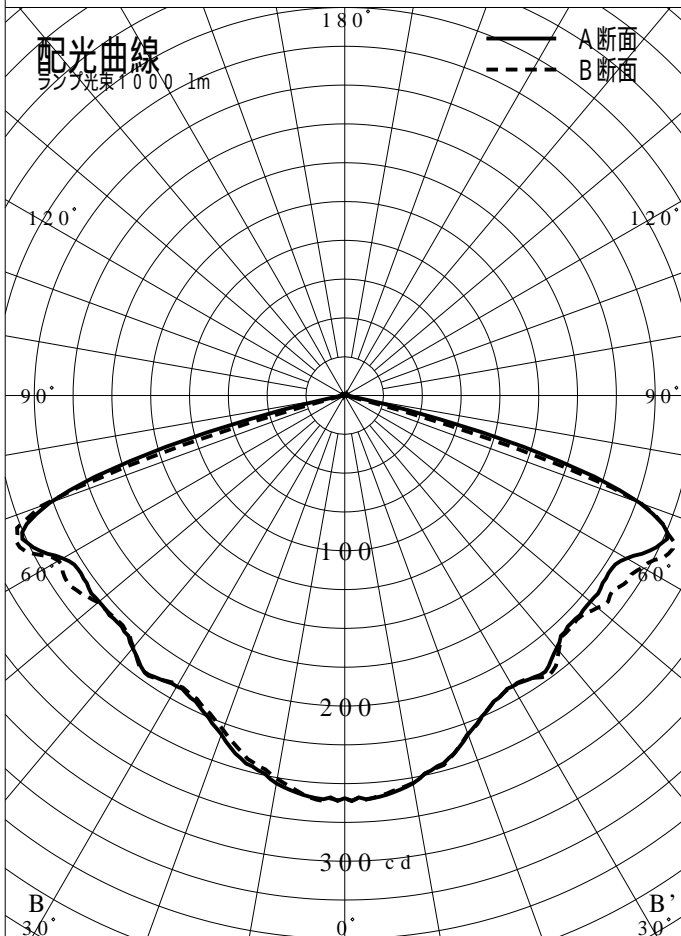

品番	XLG468DGN		
名称			
光源	LED5000/98/715		
管理番号	K0173281(0)DR1		
光束	715mm x 1.00		
保守率	0.93		
適用品番	設計照度Eを得るための読取照度		
	E=2.0	E=1.0	E=0.5
XLG468DGN	3.0	1.5	0.8

備考 非常点灯時の照度 (

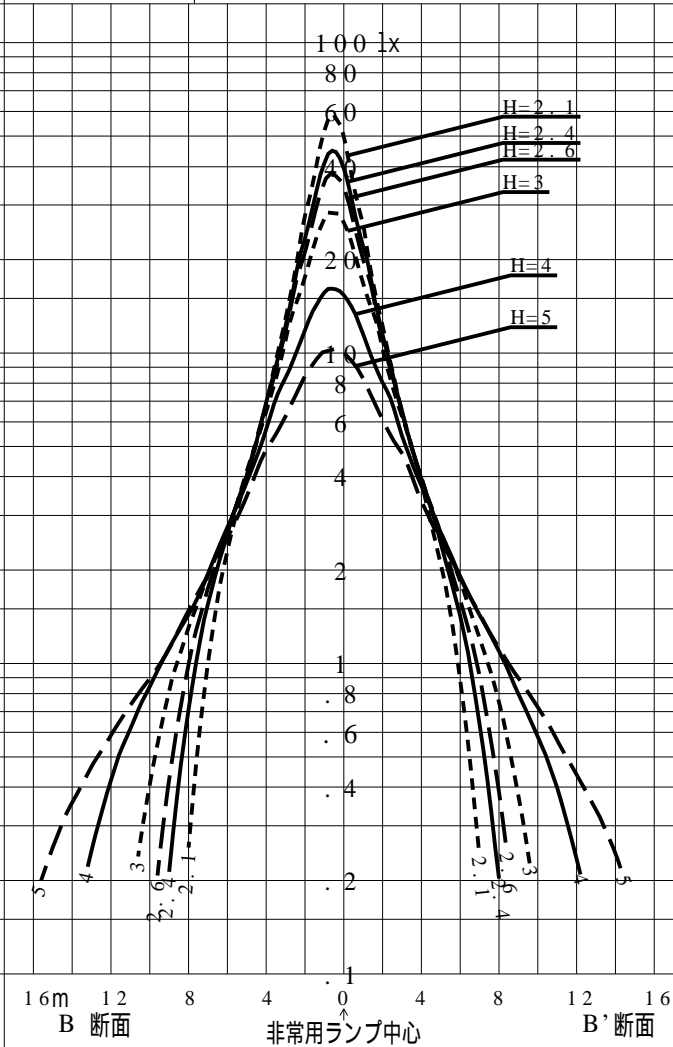
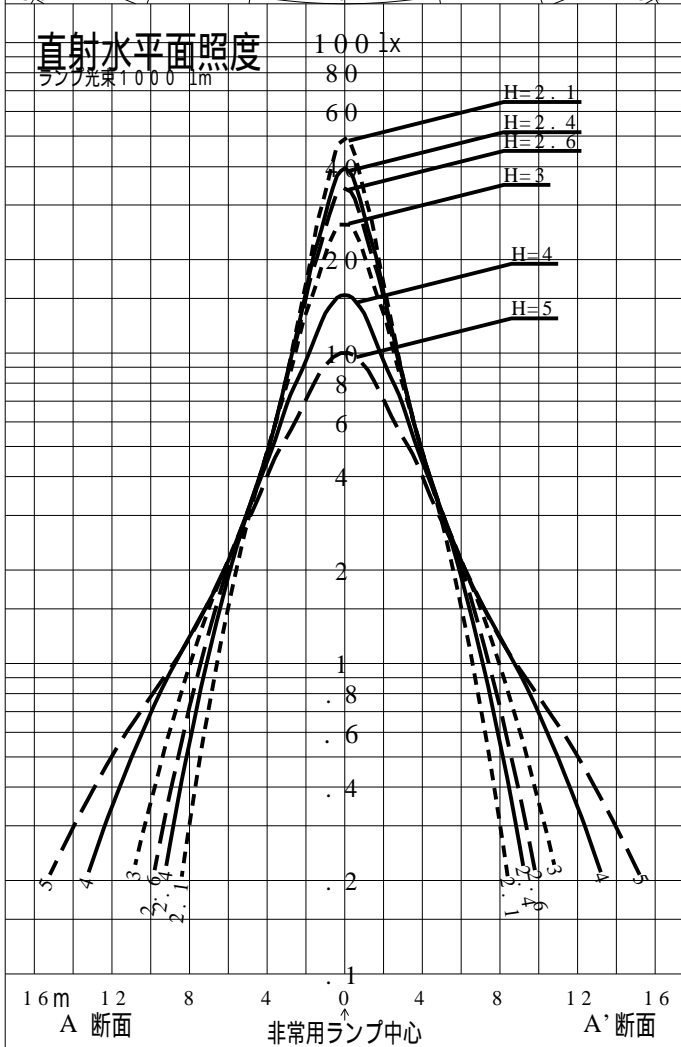

品番	XLG468DGN			
名称				
光源	LED5000/98/715			
管理番号	K0173281( 0)DR 1			
光束	715.0 1m * 1.00		備考	非常点灯時の照度 (
保守率	0.93			

非常灯配置表

器具取付高さ (m)	2.1	2.2	2.3	2.4	2.5	2.6	2.7	2.8	2.9	3.0	3.1	3.2	3.3	3.4	3.5	3.6
単体配置	A1	4.9	5.0	5.0	5.1	5.1	5.1	5.1	5.1	5.1	5.1	5.1	5.1	5.1	5.1	5.1
	B1	5.6	5.6	5.7	5.7	5.7	5.8	5.7	5.7	5.7	5.7	5.7	5.8	5.8	5.8	5.8
	B'1	4.4	4.5	4.6	4.6	4.7	4.7	4.7	4.7	4.7	4.7	4.7	4.7	4.7	4.7	4.7
直線配置	A2	11.7	12.0	12.3	12.6	12.8	13.0	13.2	13.4	13.6	13.7	13.9	13.9	14.0	14.1	14.2
	B2	11.9	12.3	12.6	12.8	13.1	13.3	13.5	13.7	13.9	14.0	14.2	14.3	14.4	14.5	14.6
四角配置	A4	9.8	10.1	10.4	10.7	11.0	11.3	11.4	11.8	11.9	12.2	12.4	12.6	12.8	13.0	13.1
	B4	9.9	10.2	10.5	10.8	11.0	11.2	11.6	11.7	12.1	12.2	12.4	12.6	12.8	13.0	13.2
壁からの距離 (最大)	A0	3.5	3.6	3.6	3.5	3.7	3.7	3.6	3.7	3.6	3.5	3.5	3.4	3.4	3.4	3.1
	B0	3.0	3.0	3.0	3.1	3.0	3.0	3.1	2.9	3.1	3.0	2.8	2.7	2.7	2.5	2.6

器具取付高さ (m)	3.7	3.8	3.9	4.0	4.1	4.2	4.3	4.4	4.5	5.0	5.5	6.0	6.5	7.0	7.5	8.0
単体配置	A1	5.1	5.1	5.1	5.1	5.1	5.1	5.1	5.0	5.0	4.9	4.7	4.6	4.3	3.8	3.3
	B1	5.8	5.8	5.8	5.7	5.7	5.7	5.7	5.6	5.6	5.5	5.3	5.2	4.9	4.3	3.9
	B'1	4.7	4.7	4.7	4.7	4.7	4.7	4.6	4.6	4.5	4.4	4.2	4.1	3.7	3.2	2.8
直線配置	A2	14.2	14.2	14.2	14.2	14.2	14.1	14.1	14.1	14.1	14.1	14.2	14.1	13.9	13.6	13.3
	B2	14.6	14.6	14.6	14.6	14.6	14.6	14.6	14.6	14.6	14.7	14.6	14.4	14.1	13.8	13.5
四角配置	A4	13.4	13.6	13.7	13.8	13.9	14.1	14.1	14.1	14.1	14.1	14.2	14.1	13.9	13.6	13.3
	B4	13.5	13.6	13.8	13.9	14.1	14.1	14.2	14.3	14.4	14.7	14.6	14.4	14.1	13.8	13.5
壁からの距離 (最大)	A0	2.9	2.8	2.5	2.4	2.2	2.2	1.9	1.7	1.6	1.0	1.1	1.2	1.0	1.2	1.1
	B0	2.2	1.9	1.9	1.6	1.6	1.2	1.0	1.0	1.2	1.0	1.1	1.1	1.0	1.2	1.1

器具取付高さ (m)	8.5	9.0														
単体配置	A1	2.3	----													
	B1	2.9	----													
	B'1	1.9	----													
直線配置	A2	12.6	12.0													
	B2	12.8	12.2													
四角配置	A4	12.6	12.0													
	B4	12.8	12.2													
壁からの距離 (最大)	A0	1.0	1.0													
	B0	1.0	1.0													