

投光照明器具特性

品名(品番)	NNY24852+NNY28476_0DEG	
光源	LED3000_70_5875 x1	5875.0 lm
管理番号	K0157153(0)DR1 TF	

配光の区分・種類	一面对称配光	主ビ-ム効率	%		
器具点灯角度		ビ-ム範囲	$I_0 / 2$	$I_0 / 10$	$I_0 / 20$
器具効率	100.0 %	ビ-ム効率	74.0%	96.0%	98.0%
最大光度	1228 cd/1000 lm	ビ-ム角	AA' 46.1 BB 100.4	70.9 124.2	76.9 137.6

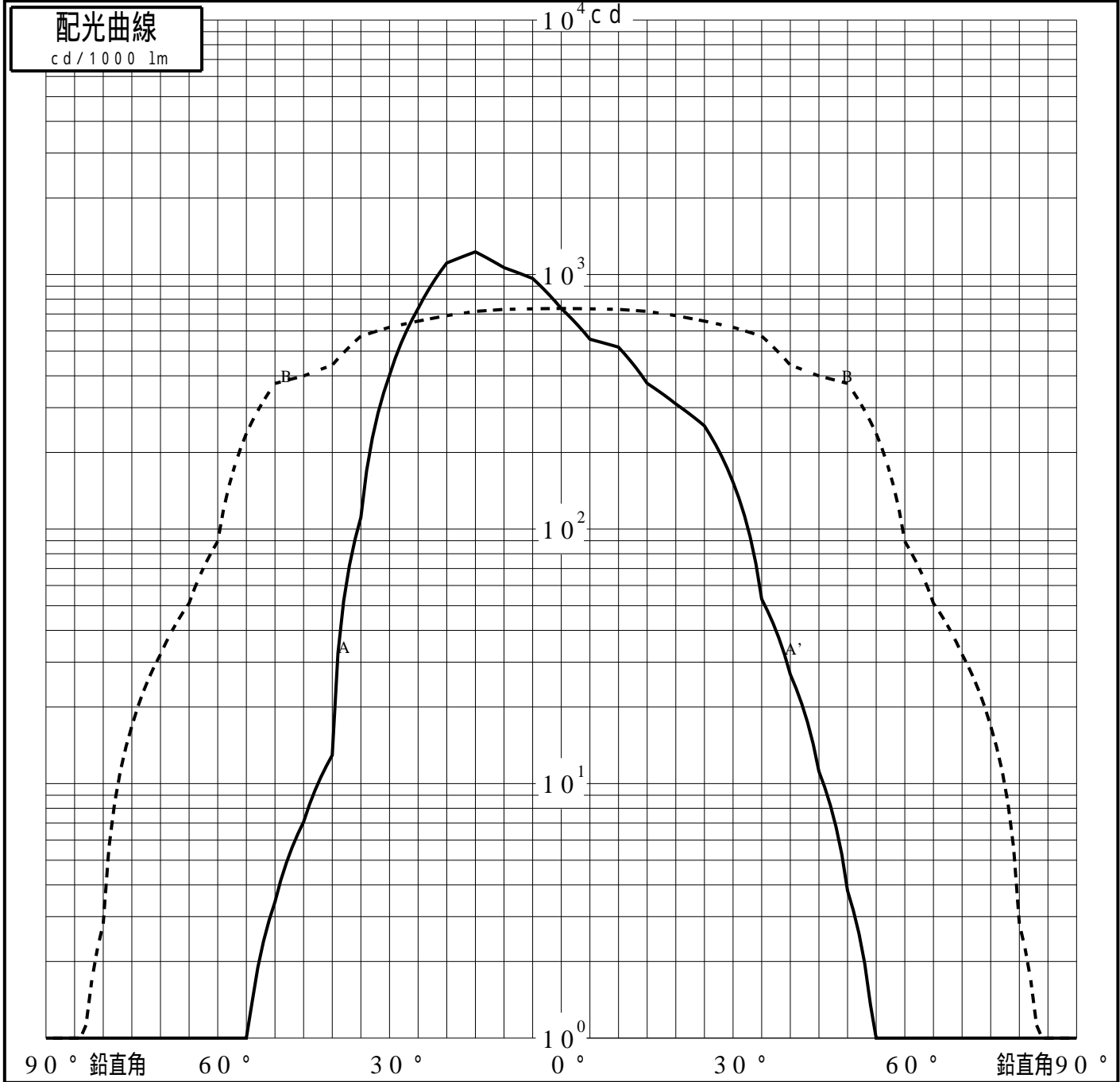
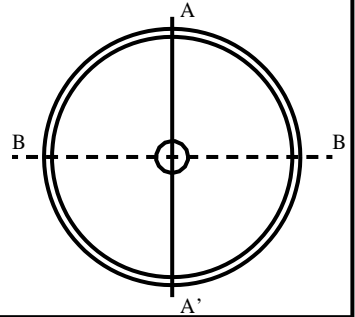

投光照明器具特性

品番 (品名)	NNY24852+NNY28476_0 DEG	光源	LED3000_70_5875 ×1
管理番号	K0157153(0) DR1 TF		

累積光束曲線

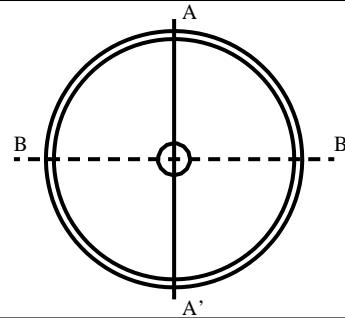
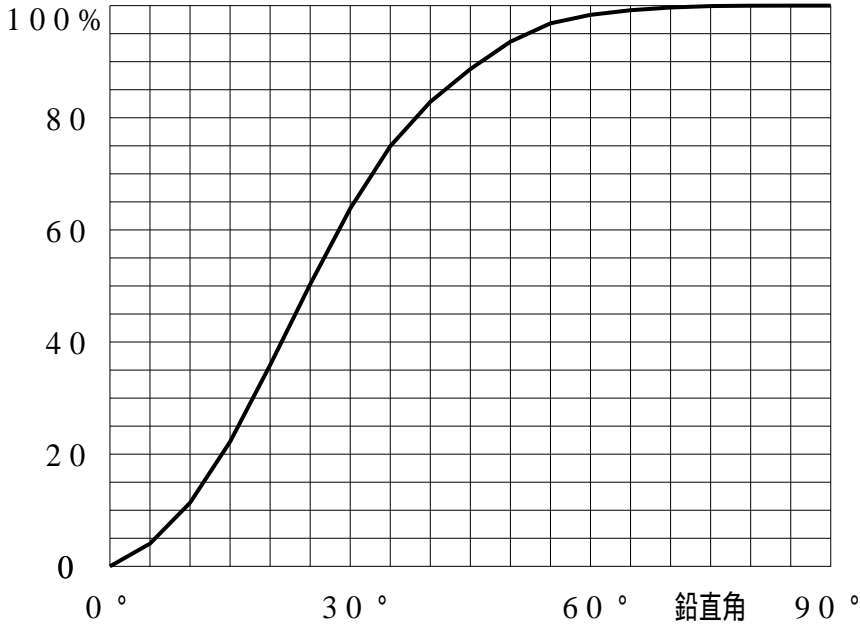

等光度曲線

(座標系)
cd/1000 lm

